

# Airwheel **SE3**

## USER MANUAL

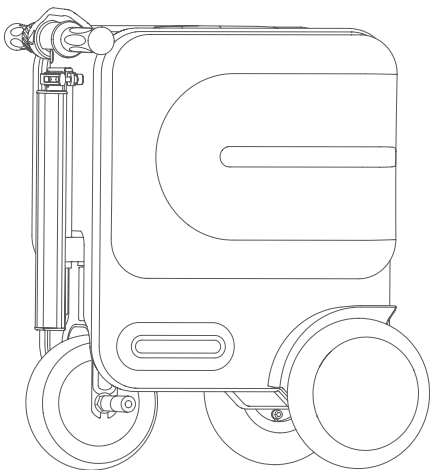



## Check Packing Contents

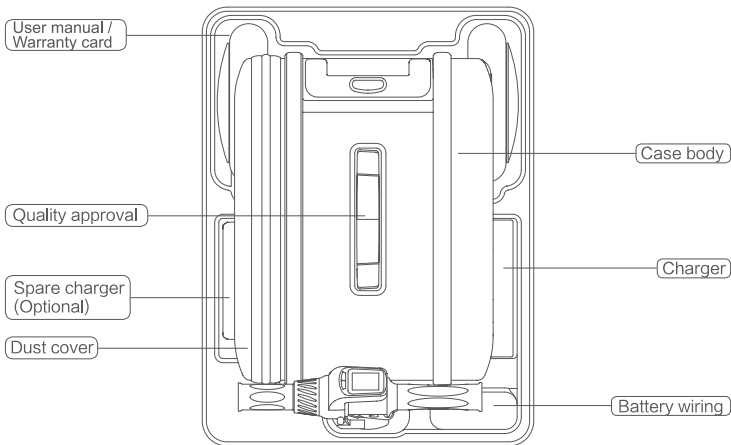

### Packing List

Case body	1 unit	Charger	1 unit
manual / Warranty card	1 unit	Quality approval	1 unit
Battery wiring	1 unit	Spare charger(Optional)	1 unit
Dust cover	1 unit	Inflatable extension nozzle(Optional)	1 unit

## SE3 Diagram

### \*Lite edition

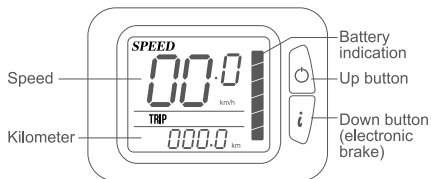
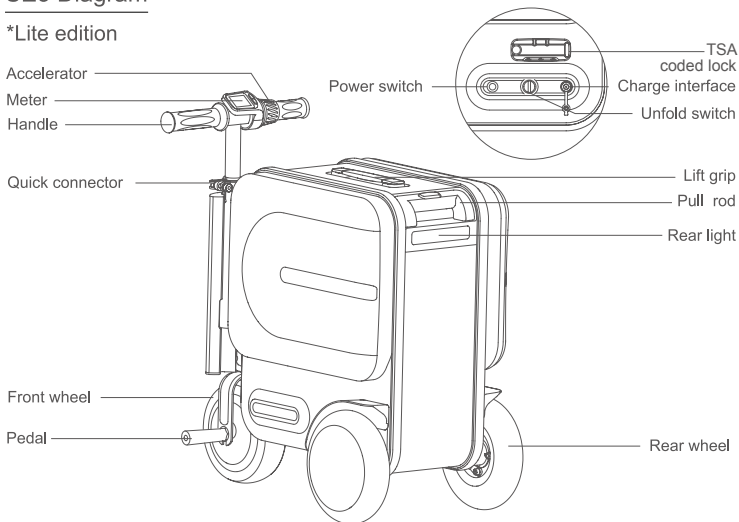

### Meter instruction

1. Short press the up button to switch between single and total distance
2. Long press the down button to activate electronic brake
3. Fault code flicker
4. Long press the up and down button 3 seconds to clear ODO distance.

## SE3 Diagram

\*Wit edition

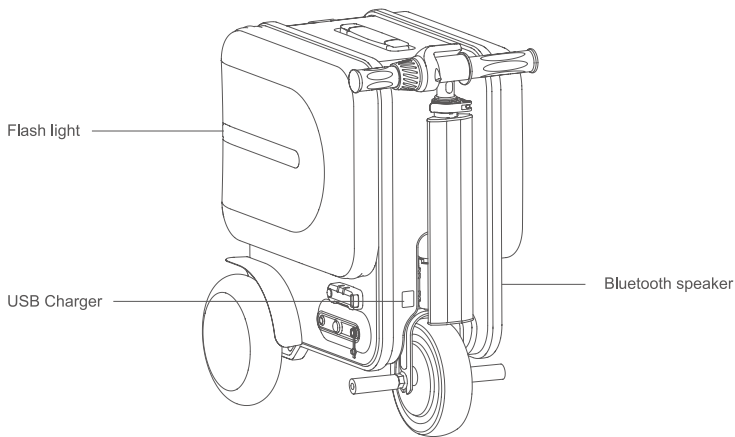

### Bluetooth speaker instruction(wit edition)

Turn on phone's bluetooth, play music once connected.

## Specifications

### Main specifications

Open size	629X365X826mm	Vehicle weight	~14.5kg
Folded size	489X365X580mm	Maximum load	100kg
USB Output voltage	5V	Maximum climbing angles	~15°
Lock type	TSA coded lock	Applicable temperature	-10℃ ~40℃
Rear wheel	8 inches X2	Volume	29.3L
Material	Shell ABS+PC Aluminum alloy frame	Front wheel	6.5 inches motor wheel
Smart phone support	IOS/Andriod	Maximum speed	≤10km/h
Pull rod	Three range aluminum rod	Color	Black/Silver

### Battery specifications

Battery capacity	185Wh/73.26Wh	Charging time	3h/2h
Battery type	lithium	Battery voltage	37V
Removable	Yes	Charging voltage	AC100-240V 50-60Hz

### Motor specifications

Motor size	6.5 inches	Motor QTY	1
Motor weight	3kg	Motor power	250W

## Warning

Please don't dispose of used batteries to avoid environmental pollution. The used lithium battery of this product is responsible for recycling by the company or distributors and government designated sites.

## Use SE3

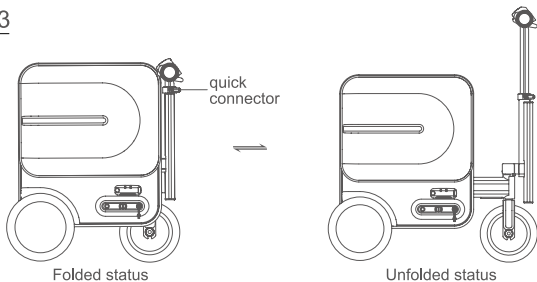

## Unfold

1. Turn on the power switch and place the unfold switch in the "I" position. The handlebars will automatically unfold. After the expansion is completed, the unfold switch will be reset to the "o" position.
2. Loosen the quick connector. After pulling the handlebar to a proper position, fasten the quick connector. Check that there is no loosening and the unfolding is complete.

## Fold

1. Turn on the power switch and place the unfold switch in the "II" position. The handlebars will automatically fold and the unfold switch will be reset to the "o" position after the folding finish. Turn off the power.
2. Loosen the quick connector, shrink the handlebar until it cannot shrink, and fasten the quick connector.



## TSA coded lock instruction

The original password is 0-0-0, set your own password, follow these steps:

1. Dial the password to the original password: 0-0-0;
2. Press the button A with a pen or other tool until you hear the 'tick' sound;
3. Dial the password wheel B to set your own password, for example: 8-8-8;
4. Push button C in the direction of the arrow and hear the "tick" sound again. Button A pops up and the password is successfully set.

Now you have completed your password setup, please keep it in mind. If you need to reset your password, repeat the above steps.

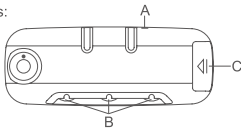

## Battery removal instructions

Before removing, check whether the power is off, open the box, pull open the lining zipper, open the inner lining, unplug the battery cable, pull out the cloth tape outside the battery box forcefully, and the battery will be lifted up and remove the battery.

(When the battery is taken out for the first time, the fixed tie on the battery box needs to be cut and removed.)

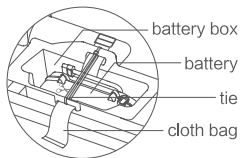

## Backup charging treasure removal instructions (optional)

Before removing, check whether the power is off, open the box, pull open the zipper, unplug the charging cable, and take out the charging treasure.

## Inflatable extension nozzle instructions (Optional)

If you need to pump the air into the tire, remove the plastic cap from the tire valve, screw on the inflatable extension nozzle, and remove the nozzle head at the other side of the inflatable extension nozzle to be ready to pump.

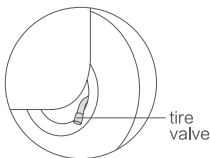
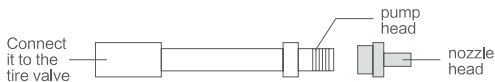

## Battery Extension Cable Instructions (Optional)

When the battery is removed for charging, connect the battery and charger as shown below.

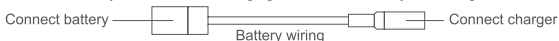

**WARNING**

### Battery connector terminal plug Note:

When inserting the battery cable terminal, please make sure the terminal "+" pole to the "+" pole, "-" pole on the "-" pole (see right diagram); never insert positive to negative poles.

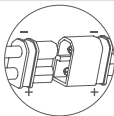



## Riding SE3

Turn on the power switch, check whether the battery is sufficient before riding, whether the brake is intact, and the charging port is covered

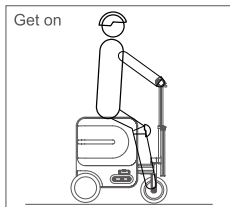

Sit on the case, adjust the center of gravity, place both feet on the pedal

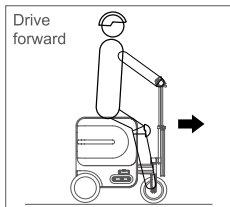

The right hand turns the accelerator to move forward

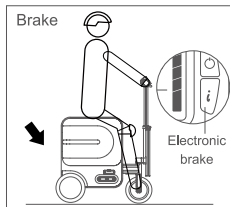

Long press the electronic brake to decelerate

## Riding precautions

1. Before using for the first time, it is recommended to charge to full battery first.
2. During the ride, it is not recommended to make sudden braking and hard turning to prevent side slipping or overturning.
3. In the process of use, please comply with the traffic regulations and various site management regulations.
4. Avoid using this product in bad weather (such as rain, snow, or ice).
5. When not riding, turn off the power.

## Towing SE3

Fold SE3, pull out rod and tow

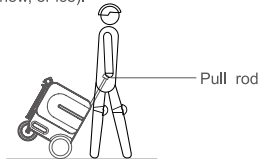

## Lifting SE3

Fold SE3, lift grip and go



## Safety

Please note that SE3 must be carefully read and follow the requirements of SE3 riding. Do not use this product until you have read the instructions carefully to understand SE3 performance; do not lend it to people who will not operate the product.

### Very important

It is strictly forbidden to accelerate, decelerate and turn sharply, or overspeed. When cell phone APP shows one cell or SE3 display voltage shows one cell, it is not recommended to ride. Please keep slow speed during riding.

If you face risk of fall, please protect your personal safety. Do not consider SE3. The SE3 may lose during riding and during parking, affecting the performance of the product. So before you ride SE3, you must do the following checks:

1. It is necessary to check whether the each components of the SE3 are installed securely, without damage, whether the brake function and tires are intact.
2. The quick connector mechanism is locked.
3. You need to have a thorough understanding of the surrounding riding environment: Make sure you are not disturbed by cars, pedestrians, pets, bicycles and other obstacles.

Before safely riding SE3, you need a lot of practice to master safe riding skills. If the riding technique is unskillful or the use of this product is not required by this guideline, personal injury or property damage to the cyclist or a third party may result. The company only assumes responsibility for product failure or damage, and does not assume responsibility for any personal injury or property damage associated with the use of this product.

### How to use the battery

1. Battery charge: If the time to production date is short, the user can directly load the battery. If the time is longer (more than 2 months), the battery will lose power during storage and transportation. The battery should be charged before you riding. Charging method: insert its original plug into the battery charging hole and then connect it to the AC100-240V power supply (commercial power) to charge it for 2 to 4 hours until the charger indication is fully charged.
2. Normal charging of the battery: The operation of the SE3 is also the discharging process of the battery. After the operation is stopped, the battery should be charged in time. Please turn off the power when not riding.
3. The connectors of the battery should be plugged and fastened as required (the battery cable has been reliably connected before leaving the factory). Loose or incorrect connections can cause abnormal operation of the relevant components. In severe cases, the components can be damaged.
4. Lithium batteries can not be close to open flame or high temperature heat source, and can not throw the power battery into the water, the battery would not allow to expose to sunlight in high temperature season.
5. Lithium batteries are well-packaged and must not be disassembled or tear down.
6. For scrapped batteries, please submit them to the recycler or distributor for disposal. Do not discard them to avoid contamination.

### How to use the charger

1. Carefully check that the charger's rated input voltage (AC100-240V) is consistent with the grid voltage.
2. When need to charge, connect the charger's input plug and the battery's charging jack in order, and then connect the charger's input to the AC power supply. When the charger's charging indicator is red, indicates that the battery is charging. When the green light is on, it will be fully charged for about 15 minutes. The charging time is about 2-4 hours (time of charging depends on the remaining battery capacity).
3. When the charging is completed, first cut off the power, pull out the power plug, pull out the charging connector, and close the charging port cover.

## Charging precautions

1. When charging, place it in a safe place that children cannot touch.
2. It should not be used without full charge.
3. Do not use other brands of charger to charge, other types of batteries should not use the charger.
4. The charger contains high voltage circuits. Do not disassemble it.
5. During use and storage, liquid and metal crumbs should be prevented from penetrating the inside of the charger. Be careful not to drop or impact them to avoid damage.
6. Never cover anything while the charger is charging.

## Precautions

1. Do not store cash or valuables in the suitcase.
2. Protective equipment such as helmets, gloves, elbow pads, and knee pads must be worn before riding to prevent accidents.
3. Before riding must confirm the safety and reliability of the brakes, cabinets, handlebars, wheels to avoid accidents.
4. Avoid riding on uneven, muddy, gravel roads, slippery roads, accumulating roads, and stairs, in case of rims deformation, incurring dangerous.
5. Handle not allow hang anything during cycling to prevent accidental operation.
6. This product is suitable for riding by one person and is prohibited from carrying people.
7. It is not recommended to ride in the cold winter.
8. It is forbidden to ride on a rainy day.
9. Do not overload or climb more than 15 degrees.
10. Pregnant women, minors under the age of 15 and senior citizens over the age of 60 are prohibited from studying and cycling.
11. Persons who are still under the influence of drugs or alcohol and who have restricted mobility and reaction are prohibited from riding.
12. If the rider is not suitable for cycling because of the rider's own reasons or other objective factors, riding is prohibited.
13. Develop a good habit of charging in time every day. When riding each time, you must fully charge the battery before the minimum allowable voltage in order to make the battery serve you longer. Therefore, it is very important to develop the habit of charging in time every day.
14. Almost all battery types are affected by the environment. In general, when the temperature is higher, the discharge performance of electricity is better. When the temperature drops below 0° C, the battery power may drop by more than one third. Therefore, when the winter comes, or in cold regions, the reduction of driving distance after one-time charging is normal. When the temperature rises above 20° C, the function will naturally recover.
15. When you lift the battery box, please be careful not to insert metal objects (such as wires, keys, etc.) into the battery charging holes or the positive and negative contacts on the battery output, to avoid short circuit, fire, and personal safety problem.
16. It is forbidden to use chargers and other accessories that are not specially provided by the company. If an accident occurs, the company will not be responsible for it.
17. Lithium batteries must not be near fire sources and should be kept away from flammable and explosive corrosive gases.
18. Do not disassemble the battery box body to avoid damage to internal parts.
19. Do not short-circuit the positive and negative electrodes of the battery with wires or conductors to avoid danger and damage the battery.
20. Lithium batteries need to be handled gently to avoid impact and fall, to prevent damage to the housing and to avoid accidents.
21. If it is not used for a long time, it must be fully charged and turned off. The maximum recharge time can not exceed 3 months from the last charge.
22. It is forbidden to dismantle or refit the vehicle without authorization. Our company will not bear the loss caused by this, and it may cause you to lose the warranty.

All rights reserved in this manual shall be the property of the company.

# How to use the spare charging treasure (optional)

1. Real-time power detection:  
Press the TEST button, the light does not light, or the 20% red light is on, indicating that the battery is low, and the green light is on to indicate that you can continue to use it.
2. Alternate charging treasure charging: If the factory date is short, the user can directly use the product. If the factory time is longer (more than 2 months), the power is lost during storage and transportation. The charging treasure should be recharged before use. The method of replenishing electricity is to plug the Airwheel dedicated DC interface charger into the charging port, and then connect the AC220V power supply for about 2 hours until the charger has a full indication.
3. When charging Po and SE3, please align the limit hole of DC37V interface, please do not reverse.
4. For charging mobile phones and digital products with DC-5V input charging (support mobile phone / MP4 / iPhone / iPad, etc.), please select the original charging cable for the charging cable.

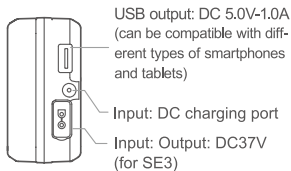
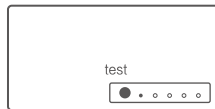

## Maintaining

### Appearance cleaning

1. Vehicles need to be cleaned at any time.
2. When cleaning dust, do not wipe the electrical parts and connectors with a damp cloth.

### Battery maintaining

1. When using it, it was found that the battery was low, it need to be recharged.
2. When not in use, turn off the switch.
3. For long-term (more than three months) not in use, it is recommended to remove the battery.

### Other maintaining

1. Regularly or according to vehicle condition, tighten the screws to prevent loosening. If you find that the screw nut is loose, stop using it.
2. Lubricate the front and rear axles once every six months.
3. Check and tighten contact of electrical connectors.
4. Handlebar: Is the quick connector loose?
5. Whether the brake is workable.

# Download APP



Scan QR code to download

\*Support Android 4.3 or higher, iOS 7.0 or higher.

## APP Instructions

1. Turn on SE3 power button, and start App as well as Bluetooth.
2. Click the search button and do as the follows to connect (verify password is 11111111).
3. Refer to official website or give calls for details.

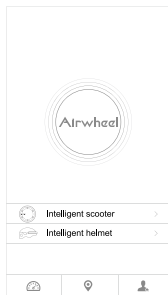

Click the Intelligent scooter in the App interface.

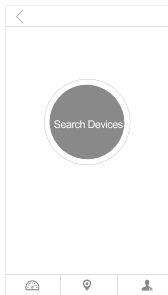

Click the search button or .

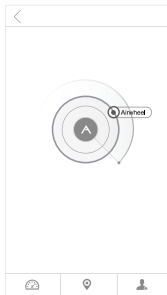

Search Airwheel nearby,click the searched Airwheel model to connect.



Input the verify password: 11111111 to connect.





